



Molded, SOT-23 Thin Film Resistor, Surface Mount Divider Network



Vishay Dale Thin Film MPM Series Dividers provide ± 2 ppm/ $^{\circ}$ C tracking and a ratio tolerance as tight as 0.01 %, small size, and exceptional stability for all surface mount applications. The standard SOT-23 package format with unity and common standard resistance divider ratios provide easy selection for most applications requiring matched pair resistor elements. The ratios listed are available for off the shelf delivery. If you require a non-standard ratio, consult the applications engineering group as we may be able to meet your requirements.

SCHEMATIC

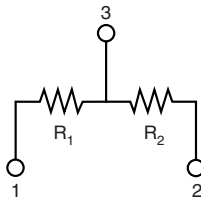

FEATURES

- Excellent long term ratio stability ($\Delta R \pm 0.015$ %, 2000 h, + 70 $^{\circ}$ C)
- Ratio tolerances to ± 0.01 %
- Low TCR tracking ± 2 ppm
- Standard JEDEC TO-236 package variation AB
- Material categorization:
For definitions of compliance please see www.vishay.com/doc?99912



RoHS*
Available
HALOGEN FREE

Note

* This datasheet provides information about parts that are RoHS-compliant and/or parts that are non-RoHS-compliant. For example, parts with lead (Pb) terminations are not RoHS-compliant. Please see the information/tables in this datasheet for details.

TYPICAL PERFORMANCE

	ABSOLUTE	TRACKING
TCR	25	2
	ABSOLUTE	RATIO
TOL.	0.1	0.05

STANDARD DIVIDER RATIO (R₂/R₁)

RATIO	R ₂ (Ω)	R ₁ (Ω)
100:1	100K	1K
50:1	50K	1K
25:1	25K	1K
20:1	20K	1K
10:1	10K	1K
9:1	9K	1K
6:1	6K	1K
5:1	10K	2K
5:1	5K	1K
4:1	8K	2K
4:1	4K	1K
2:1	10K	5K
2:1	2K	1K
1:1	50K	50K
1:1	25K	25K
1:1	10K	10K
1:1	5K	5K
1:1	2.5K	2.5K
1:1	1K	1K
1:1	500	500
1:1	250	250

STANDARD ELECTRICAL SPECIFICATIONS

TEST	SPECIFICATIONS	CONDITIONS
Material	Passivated nichrome	-
Pin/Lead Number	3	-
Resistance Range	250 Ω to 100 kΩ per resistor	-
TCR: Absolute	± 25 ppm/ $^{\circ}$ C	- 55 $^{\circ}$ C to + 125 $^{\circ}$ C
TCR: Tracking	± 2 ppm/ $^{\circ}$ C (typical)	- 55 $^{\circ}$ C to + 125 $^{\circ}$ C
Tolerance: Absolute	± 0.05 % to ± 1.0 %	+ 25 $^{\circ}$ C
Tolerance: Ratio	± 0.01 % to 0.5 %	+ 25 $^{\circ}$ C
Power Rating: Resistor	100 mW	Maximum at + 70 $^{\circ}$ C
Power Rating: Package	200 mW	Maximum at + 70 $^{\circ}$ C
Stability: Absolute	$\Delta R \pm 0.05$ %	2000 h at + 70 $^{\circ}$ C
Stability: Ratio	$\Delta R \pm 0.015$ %	2000 h at + 70 $^{\circ}$ C
Voltage Coefficient	0.1 ppm/V	-
Working Voltage	100 V max. not to exceed $\sqrt{P \times R}$	-
Operating Temperature Range	- 55 $^{\circ}$ C to + 125 $^{\circ}$ C	-
Storage Temperature Range	- 55 $^{\circ}$ C to + 150 $^{\circ}$ C	-
Noise	< - 30 dB	-
Thermal EMF	0.2 μ V/ $^{\circ}$ C	-
Shelf Life Stability: Absolute	$\Delta R \pm 0.01$ %	1 year at + 25 $^{\circ}$ C
Shelf Life Stability: Ratio	$\Delta R \pm 0.002$ %	1 year at + 25 $^{\circ}$ C

DIMENSIONS AND IMPRINTING in inches and millimeters

DIMENSION	INCHES		MILLIMETERS	
	MIN.	MAX.	MIN.	MAX.
A	0.031	0.040	0.79	1.02
A1	0.001	0.004	0.02	0.10
B	0.105	0.120	2.67	3.05
S	0.071	0.079	1.80	2.00
W	0.015	0.021	0.38	0.54
L	0.083	0.098	2.10	2.50
H	0.047	0.055	1.20	1.40
T	0.005	0.010	0.13	0.25
J	0.0035	0.0059	0.089	0.15
K	0.017	0.022	0.44	0.55
Ø	0	8°	0	8°

MECHANICAL SPECIFICATIONS	
Resistive Element	Passivated nichrome
Substrate Material	Silicon
Body	Molded epoxy
Terminals	Copper alloy
Lead (Pb)-free Option	100 % matte tin
Tin Lead Option	Sn85
Tin Lead and Lead (Pb)-free Finish	Plated

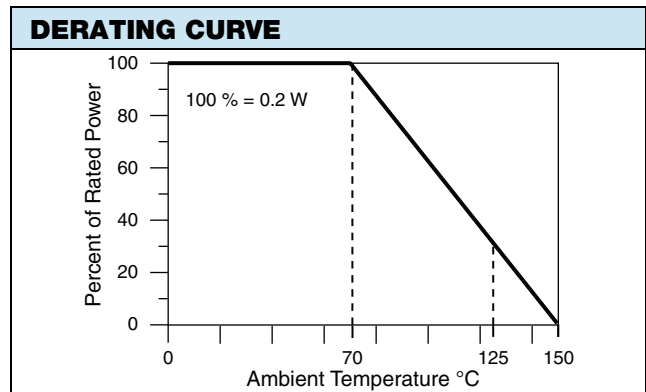
GLOBAL PART NUMBER INFORMATION

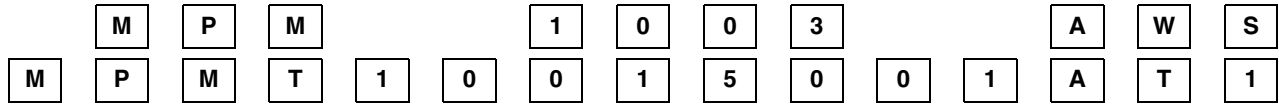
 New Global Part Numbering: **MPM1003AWS**

GLOBAL MODEL (3 or 4 digits)	RESISTANCE (4 or 8 digits)	TOLERANCE AND RATIO TOLERANCE	PACKAGING																
MPM (Tin lead) MPMT (Lead (Pb)-free) (e3)	First 3 digits are significant figures and the last digit specifies the number of zeros to follow. When like values are required use total resistance. When dual values are required list both values. Example: (List R ₁ first in part number with dual values) 1002 = 10K (5K/5K) 1003 = 100K (50K/50K) 10011002 = 1K/10K divider	<table border="1"> <thead> <tr> <th>Abs. Tol.</th> <th>Ratio</th> </tr> </thead> <tbody> <tr> <td>A = 0.1 %</td> <td>0.05 %</td> </tr> <tr> <td>B = 0.1 %</td> <td>0.1 %</td> </tr> <tr> <td>C = 0.25 %</td> <td>0.1 %</td> </tr> <tr> <td>D = 0.5 %</td> <td>0.1 %</td> </tr> <tr> <td>F = 1 %</td> <td>0.5 %</td> </tr> <tr> <td>Z = 0.1 % ⁽¹⁾</td> <td>0.025 %</td> </tr> <tr> <td>Q = 0.05 % ⁽¹⁾</td> <td>0.01 %</td> </tr> </tbody> </table>	Abs. Tol.	Ratio	A = 0.1 %	0.05 %	B = 0.1 %	0.1 %	C = 0.25 %	0.1 %	D = 0.5 %	0.1 %	F = 1 %	0.5 %	Z = 0.1 % ⁽¹⁾	0.025 %	Q = 0.05 % ⁽¹⁾	0.01 %	BS = BULK 100 min., 1 mult WS = WAFFLE 100 min., 1 mult TAPE AND REEL T0 = 100 min., 100 mult T1 = 1000 min., 1000 mult ⁽²⁾ T3 = 300 min., 300 mult T5 = 500 min., 500 mult TF = Full reel 4000 TS = 100 min., 1 mult
Abs. Tol.	Ratio																		
A = 0.1 %	0.05 %																		
B = 0.1 %	0.1 %																		
C = 0.25 %	0.1 %																		
D = 0.5 %	0.1 %																		
F = 1 %	0.5 %																		
Z = 0.1 % ⁽¹⁾	0.025 %																		
Q = 0.05 % ⁽¹⁾	0.01 %																		

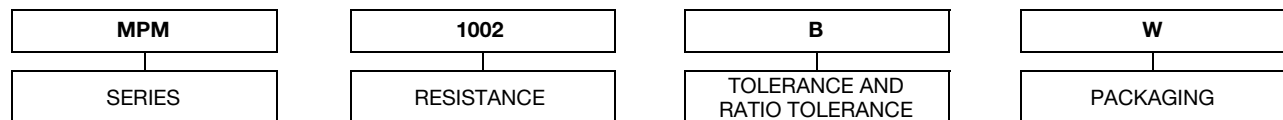
 Historical Part Number example: **MPM1002BW** (for reference purposes only)

Notes

- (1) Tol. available 1K and up equal values only
 (2) Preferred packaging code



Vishay Dale Thin Film Land Patterns

1. Scope

This technical note provides sample land patterns for Vishay Dale Thin Film SMT resistive products. The following drawings are based on IPC-SM-782 Surface Mount Design and Land Pattern Standard. These drawings are for reference only Vishay Thin Film recommends that the user contacts their PC board supplier for actual land patterns required. The pads are intended for lead (Pb)-free and tin / lead solder types.

2. Product Series

Thin Film Surface Mount Chip Resistors (FC, L, P, PTN, PLT, PLTT, PLTU, PAT, PATT, PNM, M/D55342 QPL Series)

0402 Land Pattern

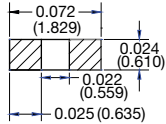

0502 Land Pattern

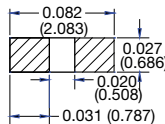

0505 Land Pattern

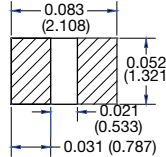

0603 Land Pattern

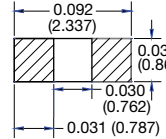

0705 Land Pattern

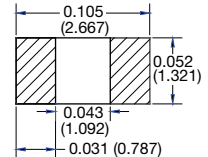

1005 Land Pattern

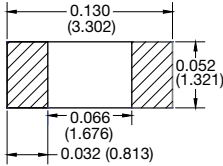

1010 Land Pattern

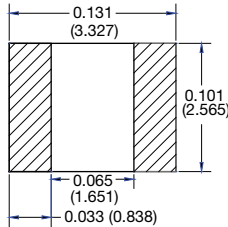

1206 Land Pattern

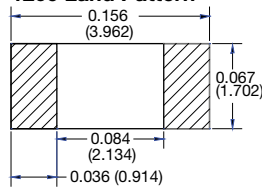

1505 Land Pattern

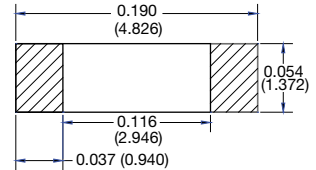

2010 Land Pattern

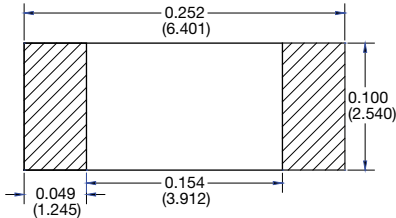

2208 Land Pattern

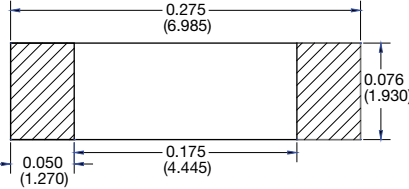

2512 Land Pattern

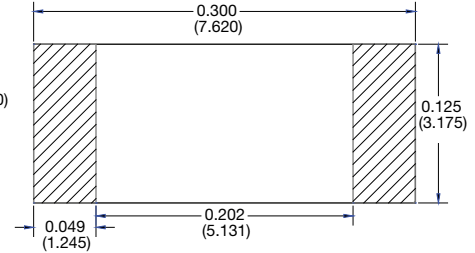



Thin Film Surface Mount Chip Resistors (PHP, PCAN Series)

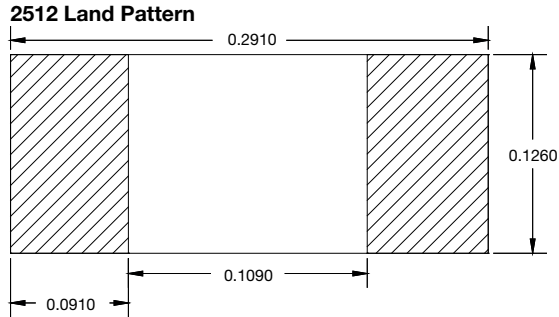
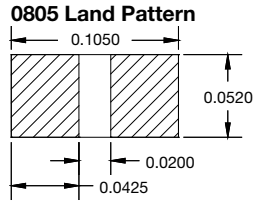
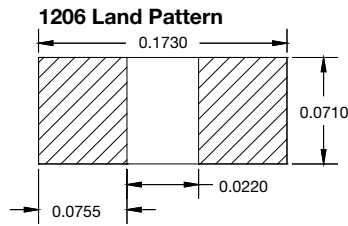
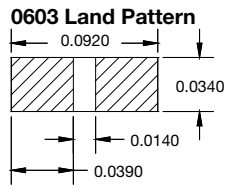

Thin Film Surface Mount Chip Resistors Long Axis Termination (L Series)

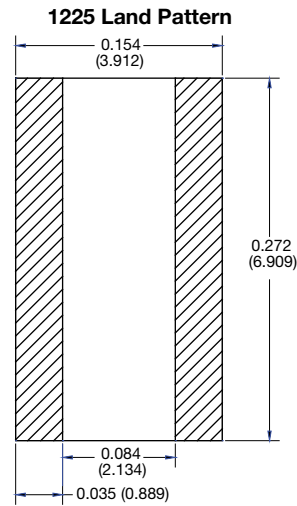
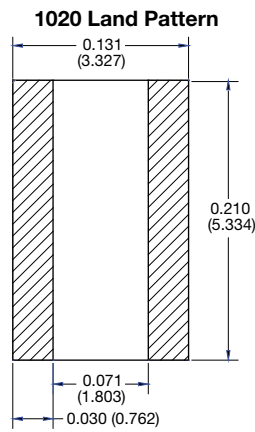
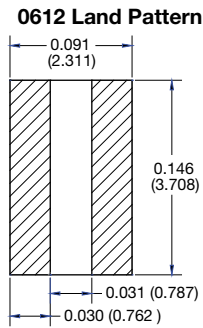
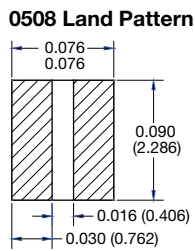



Surface Mount Networks (MPM, MP3, MP4 Series)

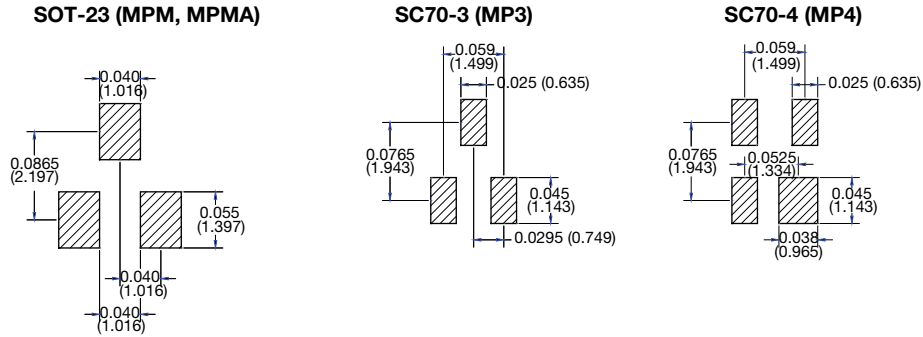

Surface Mount Networks SOIC Narrow Body 150 mils (ORN, CSO, MOMC, HTRN, AORN, MORN Series)

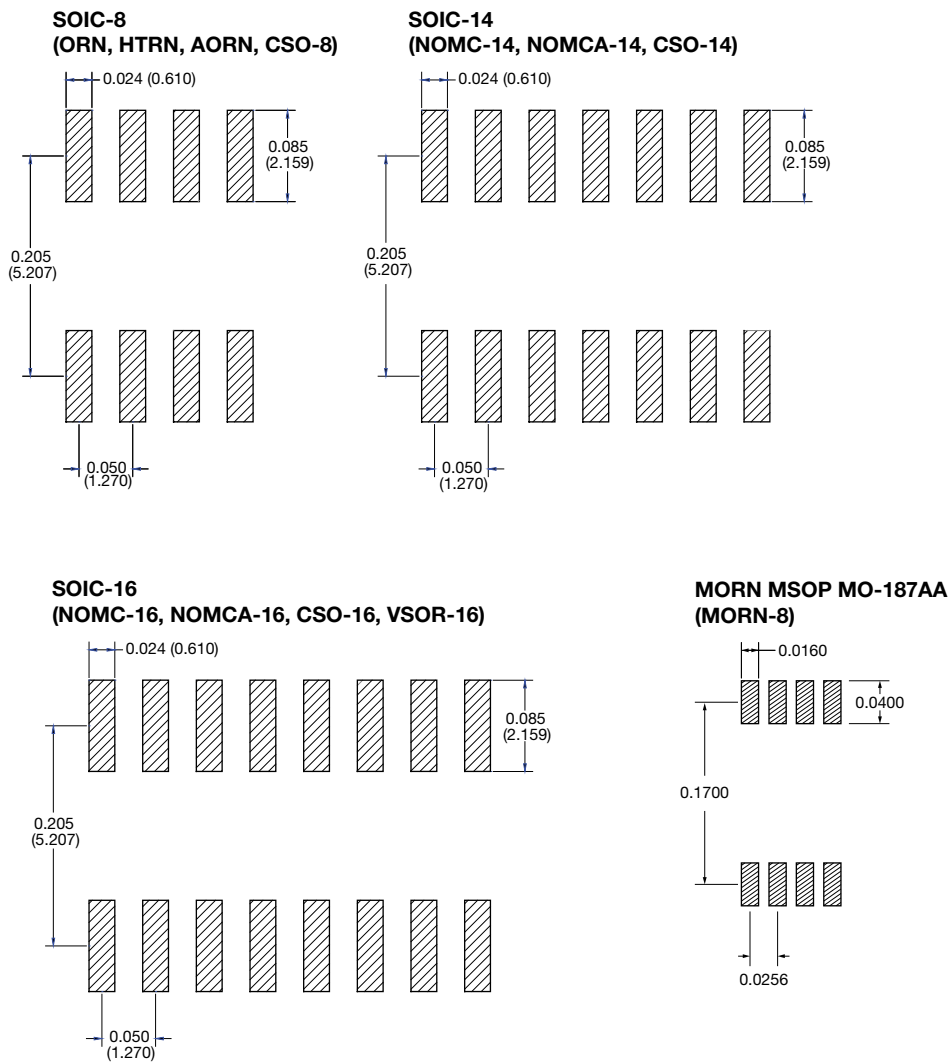



Surface Mount Networks SOIC Medium Body 220 mils (TOMC Series)

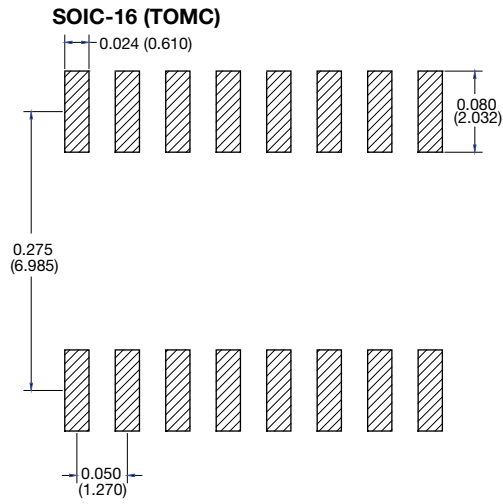

Surface Mount Networks SOIC Wide Body 300 mils (WOMC Series)

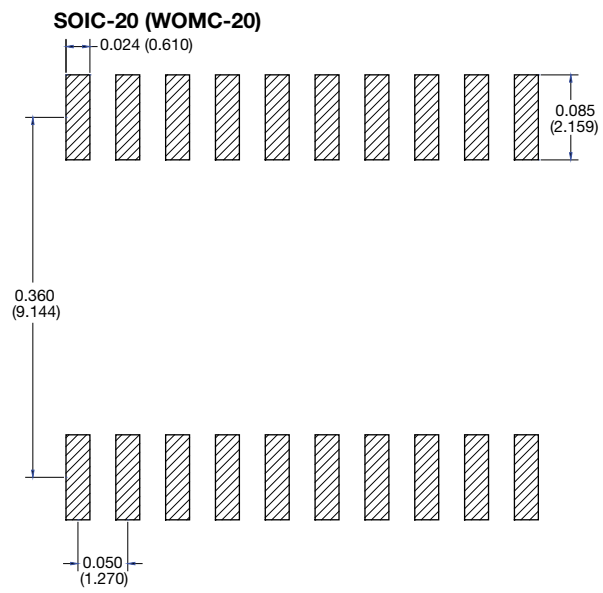
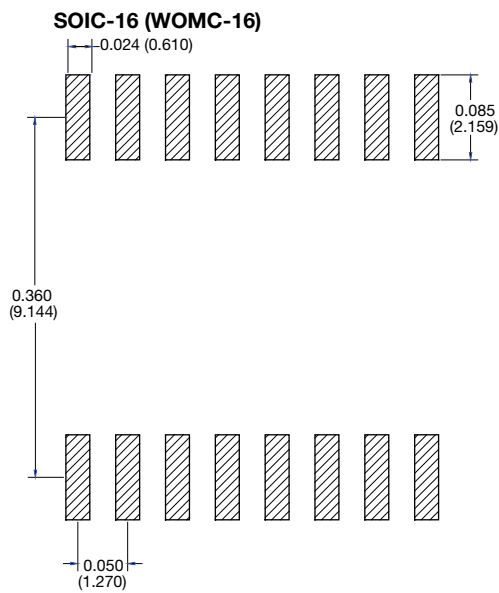



Surface Mount Networks High Density SSOP, TSOP (VSSR, VTSR Series)

SSOP MO-137

OSOP-16, VSSR-16

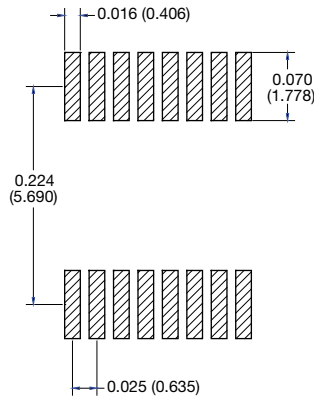

OSOP-20, VSSR-20

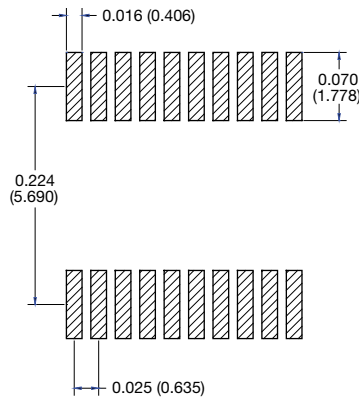

OSOP-24, VSSR-24, HD-CSO-24

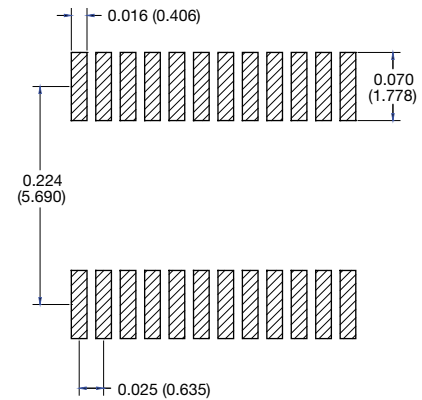

TSSOP MO-153

VTSR-16

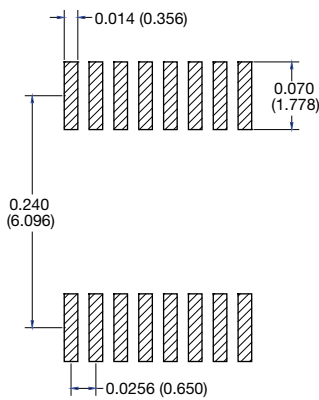

VTSR-20

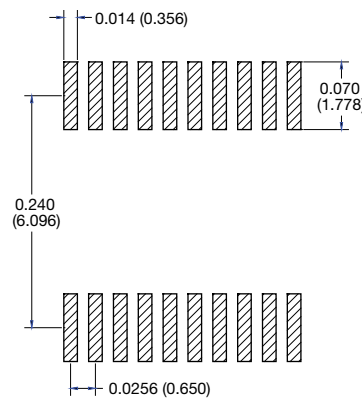

VTSR-24

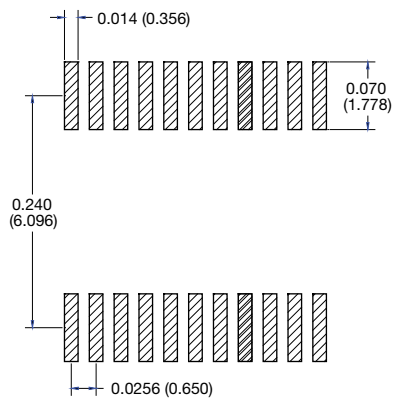

Surface Mount Leadless Networks (LCC Series)

16 Pin LCC

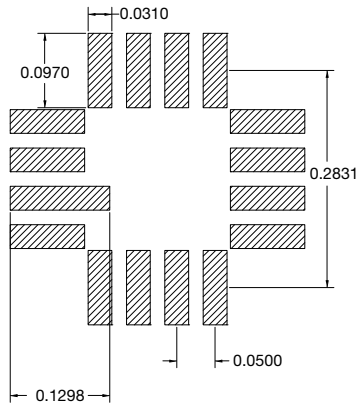

20 Pin LCC

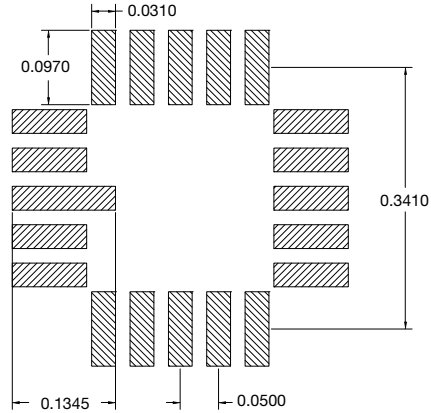

Surface Mount Leadless Networks (MPH Series)

4 Pin LCC

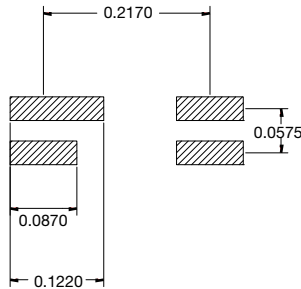

Surface Mount Leadless Packages DUAL/ QUAD Flat No Lead (DFN, QFN Series)

DFN MLP

DFN-8 4 x 5 mm Sq

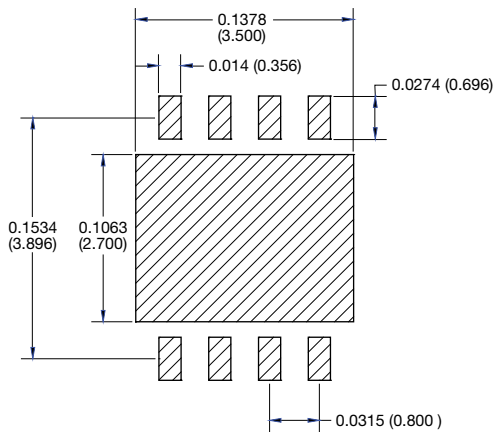

QFN MLP

QFN-20 5 x 5 mm Sq

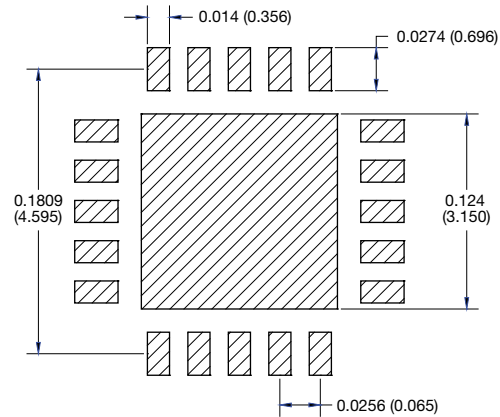

Surface Mount Leadless Resistor Arrays (PR Series)

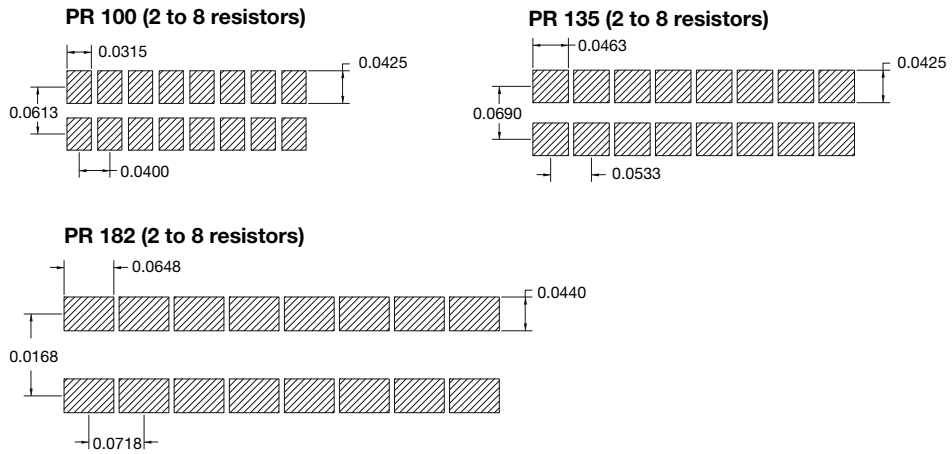

Note

- All dimensions in inches (mm)

Flatpack

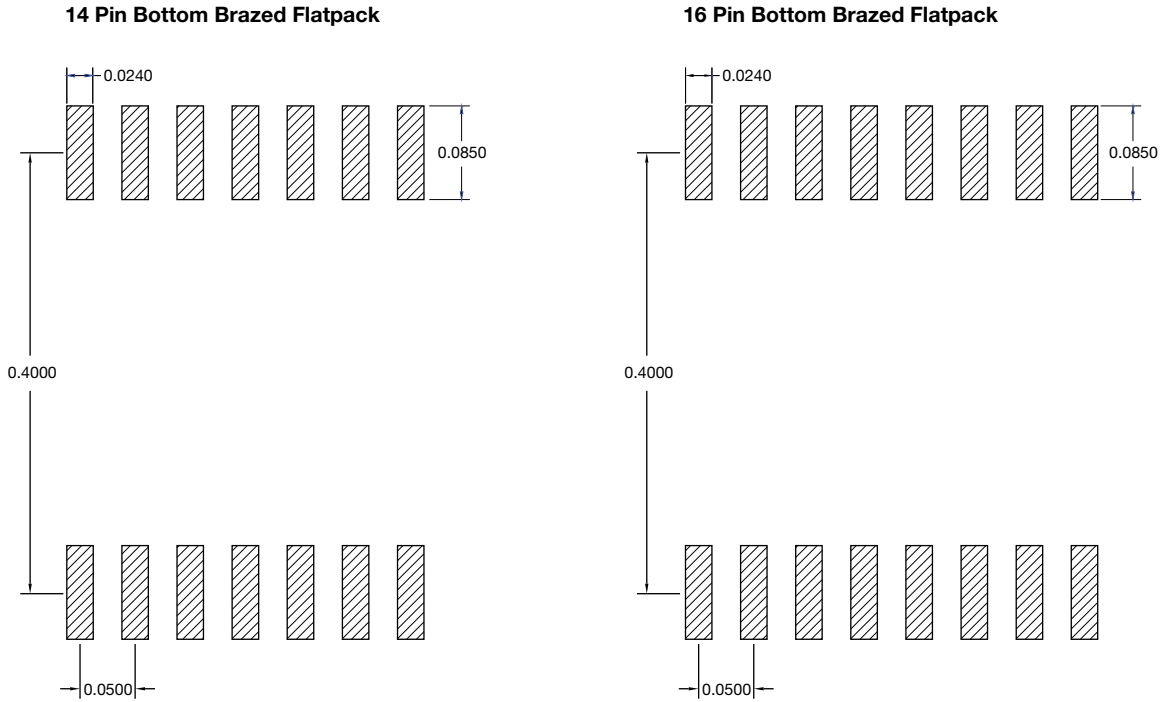



Disclaimer

ALL PRODUCT, PRODUCT SPECIFICATIONS AND DATA ARE SUBJECT TO CHANGE WITHOUT NOTICE TO IMPROVE RELIABILITY, FUNCTION OR DESIGN OR OTHERWISE.

Vishay Intertechnology, Inc., its affiliates, agents, and employees, and all persons acting on its or their behalf (collectively, "Vishay"), disclaim any and all liability for any errors, inaccuracies or incompleteness contained in any datasheet or in any other disclosure relating to any product.

Vishay makes no warranty, representation or guarantee regarding the suitability of the products for any particular purpose or the continuing production of any product. To the maximum extent permitted by applicable law, Vishay disclaims (i) any and all liability arising out of the application or use of any product, (ii) any and all liability, including without limitation special, consequential or incidental damages, and (iii) any and all implied warranties, including warranties of fitness for particular purpose, non-infringement and merchantability.

Statements regarding the suitability of products for certain types of applications are based on Vishay's knowledge of typical requirements that are often placed on Vishay products in generic applications. Such statements are not binding statements about the suitability of products for a particular application. It is the customer's responsibility to validate that a particular product with the properties described in the product specification is suitable for use in a particular application. Parameters provided in datasheets and / or specifications may vary in different applications and performance may vary over time. All operating parameters, including typical parameters, must be validated for each customer application by the customer's technical experts. Product specifications do not expand or otherwise modify Vishay's terms and conditions of purchase, including but not limited to the warranty expressed therein.

Except as expressly indicated in writing, Vishay products are not designed for use in medical, life-saving, or life-sustaining applications or for any other application in which the failure of the Vishay product could result in personal injury or death. Customers using or selling Vishay products not expressly indicated for use in such applications do so at their own risk. Please contact authorized Vishay personnel to obtain written terms and conditions regarding products designed for such applications.

No license, express or implied, by estoppel or otherwise, to any intellectual property rights is granted by this document or by any conduct of Vishay. Product names and markings noted herein may be trademarks of their respective owners.